



**MASONITE.**

Open to extraordinary.

# INTERIOR & WOOD DOORS

STOCK DOOR BROCHURE



Refer to full line catalog for more options and non-stock availability.

**SHUSTER'S**  
BUILDING COMPONENTS





# MASONITE.

Open to extraordinary.

Masonite and Shuster's Building Components are committed to delivering unsurpassed performance in interior and exterior doors and glass products. We provide much more than a door; we deliver a total experience, giving you a complete line of products, services and support tools designed to enhance curb appeal and the interior aesthetics of a home.

We are your leading source for the latest trend insights and design ideas, delivering distinctive doors that complement any style and personal taste. From the crisp, clean lines of our Heritage Series, to the versatility of our molded panel collection, we offer a breadth of interior doors to meet any design, performance and material need. It's never been easier to find the perfect door for your home.

**SHUSTER'S**  
**BUILDING COMPONENTS**



Unique. Versatile. Timeless.

# INTRODUCING THE LIVINGSTON™ p08



Shuster's Strong // 04

Interior Doors // 06

Safe 'N Sound. // 07

**NEW** Livingston™ // 08

Heritage Series.. // 11

West End Collection. // 14

Molded Panel Doors // 16

Flush Series // 24

6P Prefinished // 29

Hardwood Lites // 30

Anatomy of a Door // 31

Door Accessories // 32

Barn Door Hardware // 33

Door Hanging Chart // 34

# Shuster's Building Components



## SHUSTER'S STRONG

is a motto we use that we feel describes our business on several different levels

- ▶ **DELIVERIES** — We are the quickest in the marketplace!
- ▶ **HANDS ON OWNERSHIP** ensures ultimate customer satisfaction.
- ▶ **STATE OF THE ART MACHINERY/TECHNOLOGY** provides precision and accuracy.
- ▶ **PRIDE** of a workforce with thousands of years of tenure.
- ▶ Outside **SALES TEAM THAT SUPPORTS OUR DEALERS**, backed by a knowledgeable inside sales staff that is readily available.
- ▶ 3rd generation — **FAMILY OWNED** — hands on independent organization allows for quick decisive decision making, ensuring dependable service and quality products.





Look for our new 2019 beast family of products. The beast collection provides for unmatched strength, long lasting durability, convenience and style to both the new and remodeling construction.

We think you will find this collection will be an exciting resource of offerings for you and your customers.



# Interior Doors

## AT A GLANCE

Our dedication to superior craftsmanship allows us to deliver unsurpassed quality and value in interior doors. We offer a comprehensive selection of door styles—all crafted with exacting attention to detail.

### LIVINGSTON™

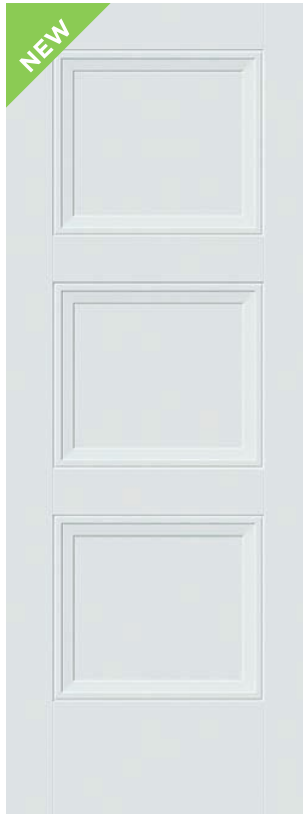

► Unique, versatile, and timeless design perfect for any style of home.



### HERITAGE SERIES™



► Celebrate traditional craftsmanship with clean lines that blend seamlessly with their surroundings.



### WEST END COLLECTION®

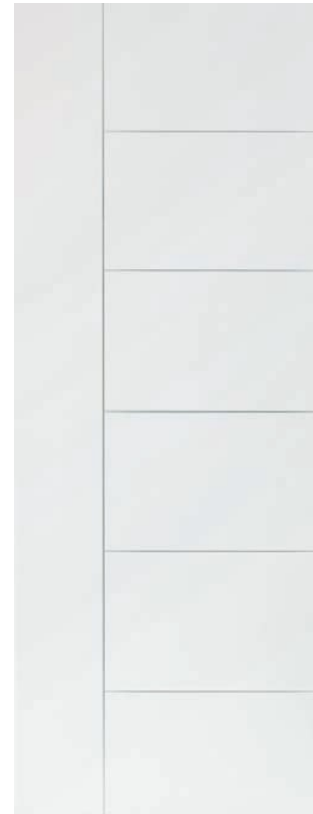

► Embrace the beauty of minimalism with the sophisticated, streamlined look of embossed lines.



Masonite, "Masonite. Open to extraordinary.", Safe 'N Sound, Berkley, Cheyenne, Heritage Series, Lincoln Park, Livingston, Logan, Melrose, Riverside, Saddlebrook, West End Collection, and Winslow, are trademarks of Masonite International Corporation. Doors made using patents 6,588,162 (US), 5,543,234 (US) and 2,151,989 (CA). Additional Patents Pending. Our continuing program of product improvement makes specification, design and product detail subject to change without notice. 01/19 PRINTED IN THE USA © 2019 Masonite International Corporation



Safe 'N Sound.

**THE NEW STANDARD**

# SOLID CORE DOORS

## MOLDED PANEL DOORS



- ▶ Add a defining element to any space with familiar designs that offer timeless appeal.



We are on a mission to put solid core doors in every home. Made of solid material all the way through, they feel more substantial and block sound more effectively. For minimal cost, solid core doors create a dramatic improvement in overall quality.

- ▶ Solid core doors are **SOUND REDUCING**  
They block sound more efficiently than hollow doors.
- ▶ Solid core doors are simply built better with a strength you can **FEEL** the moment you open the door.
- ▶ Solid core doors are **DURABLE**, able to withstand the dents and dings of normal wear.

# Unique. Versatile. Timeless.

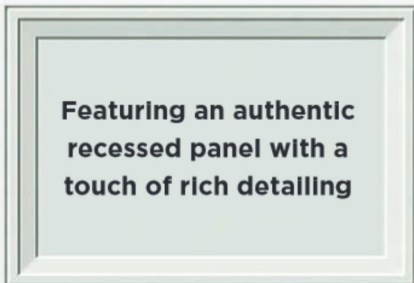

Featuring an authentic recessed panel with a touch of rich detailing

**The Livingston. door** instantly transforms any interior with a unique profile that is universally appealing. Set yourself apart by choosing the only interior door designed to make a lasting statement.





## INTRODUCING THE LIVINGSTON™

Masonite's exclusive new  
design is making homeowners  
**STOP AND TAKE NOTICE  
OF THEIR DOORS.**



- ▶ Unique, versatile and timeless design perfect for any style of home
- ▶ Smooth, primed surface ideal for painting
- ▶ Full range of passage and bifold doors
- ▶ Safe 'N Sound. solid core construction available for better durability, sound reduction and the heft and feel of a wood door
- ▶ 20-minute fire-rating doors available for select heights & designs (1-3/4" width only)

**NEW**

# LIVINGSTON™



- ▶ Featuring an authentic recessed panel with a touch of rich detailing
- ▶ Available in Safe 'N Sound, see page 7 for details.



10" Bottom Rail

LIVINGSTON.	1-3/8"						1-3/4"		
	6'8"		7'0"		8'0"		6'8"	7'0"	8'0"
	HC	SC	HC	SC	HC	SC	SC	SC	SC
12"	.	.	.	.	.	.	.	.	.
14"	.	.	.	.	.	.	.	.	.
15"	.	.	.	.	.	.	.	.	.
16"	.	.	.	.	.	.	.	.	.
18"	S	.	.	.	.	.	.	.	.
20"	.	.	.	.	.	.	.	.	.
22"	.	.	.	.	.	.	.	.	.
24"	S	.	.	.	.	.	.	.	.
26"	.	.	.	.	.	.	.	.	.
28"	S	.	.	.	.	.	.	.	.
30"	S	.	.	.	.	.	.	.	.
32"	S	.	.	.	.	.	.	.	.
34"	.	.	.	.	.	.	.	.	.
36"	S	.	.	.	.	.	.	.	.

CARTON PACK	
24"	S
28"	.
30"	S
32"	.
36"	S

Note: All 1-3/4" doors come 20-minute fire-rated.

HC Hollow Core    SC Solid Core    S - Stock

# HERITAGE SERIES™

## Lincoln Park.



- ▶ Classic Shaker style meets modern engineering in this versatile collection.
- ▶ Available in Safe 'N Sound., see page 7 for details.



10" Bottom Rail

LINCOLN PARK.	1-3/8"						1-3/4"		
	6'8"		7'0"		8'0"		6'8"	7'0"	8'0"
	HC	SC	HC	SC	HC	SC	SC	SC	SC
12"	S	•	•	•	•	•	•	•	•
14"	S	•	•	•	•	•	•	•	•
15"	S	•	•	•	•	•	•	•	•
16"	S	•	•	•	•	•	•	•	•
18"	S	S	•	•	•	•	•	•	•
20"	S	•	•	•	•	•	•	•	•
22"	S	•	•	•	•	•	•	•	•
24"	S	S	•	•	S	•	•	•	•
26"	S	•	•	•	•	•	•	•	•
28"	S	S	•	•	S	•	•	•	•
30"	S	S	•	•	S	•	•	•	•
32"	S	S	•	•	S	•	S	•	S
34"	S	•	•	•	•	•	•	•	•
36"	S	S	•	•	S	•	S	•	S

CARTON PACK	
24"	S
28"	•
30"	S
32"	•
36"	S

Note: All 1-3/4" doors come 20-minute fire-rated.

HC Hollow Core    SC Solid Core    S - Stock

# HERITAGE SERIES™

Logan.



- ▶ Classic Shaker style meets modern engineering in this versatile collection.
- ▶ Available in Safe 'N Sound., see page 7 for details.



10" Bottom Rail

LOGAN.	1-3/8"						1-3/4"		
	6'8"		7'0"		8'0"		6'8"	7'0"	8'0"
	HC	SC	HC	SC	HC	SC	SC	SC	SC
12"	S	.	.	.	.	.	.	.	.
14"	S	.	.	.	.	.	.	.	.
15"	S	.	.	.	.	.	.	.	.
16"	S	S	.	.	.	.	.	.	.
18"	S	.	.	.	.	.	.	.	.
20"	S	.	.	.	.	.	.	.	.
22"	S	.	.	.	.	.	.	.	.
24"	S	S	.	.	S	.	.	.	.
26"	S	.	.	.	.	.	.	.	.
28"	S	S	.	.	S	.	.	.	.
30"	S	S	.	.	S	.	.	.	.
32"	S	S	.	.	S	.	S	.	S
34"	S	.	.	.	.	.	.	.	.
36"	S	S	.	.	S	.	S	.	S

CARTON PACK	
24"	S
28"	.
30"	S
32"	.
36"	S

Note: All 1-3/4" doors come 20-minute fire-rated.

HC Hollow Core SC Solid Core S - Stock



# HERITAGE SERIES™

Winslow.



- ▶ Classic Shaker style meets modern engineering in this versatile collection.
- ▶ Available in Safe 'N Sound., see page 7 for details.



10" Bottom Rail

WINSLOW.	1-3/8"				1-3/4"	
	6'8"	SC	7'0"	SC	6'8"	7'0"
	HC	SC	HC	SC	SC	SC
12"	S	•	•	•	•	•
14"	S	•	•	•	•	•
15"	S	•	•	•	•	•
16"	S	•	•	•	•	•
18"	S	S	•	•	•	•
20"	S	•	•	•	•	•
22"	S	•	•	•	•	•
24"	S	S	•	•	•	•
26"	S	•	•	•	•	•
28"	S	S	•	•	•	•
30"	S	S	•	•	•	•
32"	S	S	•	•	S	•
34"	S	•	•	•	•	•
36"	S	S	•	•	S	•

CARTON PACK	
24"	S
28"	•
30"	S
32"	•
36"	S

Note: All 1-3/4" doors come 20-minute fire-rated.

HC Hollow Core    SC Solid Core    S - Stock

# WEST END COLLECTION.

## Melrose.

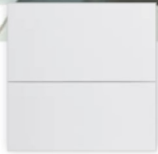

- ▶ Embossed lines add a modern edge to any space.
- ▶ Available in Safe 'N Sound, see page 7 for details.
- ▶ Not recommended for double door application.

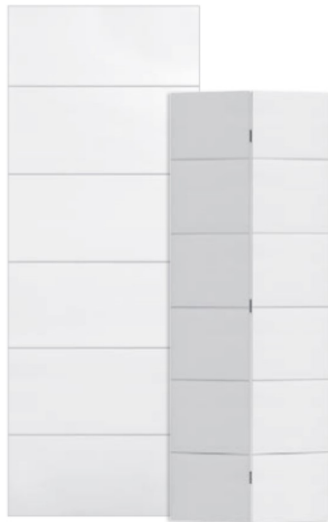

MELROSE	1-3/8"				1-3/4"	
	6'8"		7'0"		6'8"	7'0"
	HC	SC	HC	SC	SC	SC
12"	•	•	•	•	•	•
14"	•	•	•	•	•	•
15"	•	•	•	•	•	•
16"	•	•	•	•	•	•
18"	S	S	•	•	•	•
20"	•	•	•	•	•	•
22"	•	•	•	•	•	•
24"	S	S	•	•	•	•
26"	•	•	•	•	•	•
28"	S	S	•	•	•	•
30"	S	S	•	•	•	•
32"	S	S	•	•	S	•
34"	•	•	•	•	•	•
36"	S	S	•	•	S	•

CARTON PACK	
24"	
28"	
30"	
32"	
36"	

Note: All 1-3/4" doors come 20-minute fire-rated.

HC Hollow Core    SC Solid Core    S - Stock

# WEST END COLLECTION.

Berkley.



- ▶ Embossed lines add a modern edge to any space.
- ▶ Available in Safe 'N Sound., see page 7 for details.



BERKLEY.	1-3/8"				1-3/4"	
	6'8"		7'0"		6'8"	7'0"
	HC	SC	HC	SC	SC	SC
12"	.	.	.	.	.	.
14"	.	.	.	.	.	.
15"	.	.	.	.	.	.
16"	.	.	.	.	.	.
18"	S	S	.	.	.	.
20"	.	.	.	.	.	.
22"	.	.	.	.	.	.
24"	S	S	.	.	.	.
26"	.	.	.	.	.	.
28"	S	S	.	.	.	.
30"	S	S	.	.	.	.
32"	S	S	.	.	S	.
34"	.	.	.	.	.	.
36"	S	S	.	.	S	.

CARTON PACK	
24"	
28"	
30"	
32"	
36"	

Note: All 1-3/4" doors come 20-minute fire-rated.

HC Hollow Core    SC Solid Core    S - Stock

# MOLDED PANEL DOORS

## 2 Panel Square



- ▶ Molded panel engineering delivers timeless designs that resist warping, shrinking and cracking.
- ▶ Available in Safe 'N Sound., see page 7 for details.



Available with  
10" Bottom Rail  
(EXTRA CHARGE)

2P SQUARE	1-3/8"						1-3/4"		
	6'8"		7'0"		8'0"		6'8"	7'0"	8'0"
	HC	SC	HC	SC	HC	SC	SC	SC	SC
12"	S	S	.	.	.	.	.	.	.
14"	S	S	.	.	.	.	.	.	.
15"	S	S	.	.	.	.	.	.	.
16"	S	S	.	.	.	.	.	.	.
18"	S	S	S	S	S	S	S	.	.
20"	S	S	.	.	.	.	.	.	.
22"	S	S	.	.	.	.	.	.	.
24"	S	S	S	S	S	S	S	.	S
26"	S	S	.	.	.	.	.	.	.
28"	S	S	S	S	S	S	S	.	S
30"	S	S	S	S	S	S	S	.	S
32"	S	S	S	S	S	S	S	.	S
34"	S	S	.	.	.	.	.	.	.
36"	S	S	S	S	S	S	S	.	S

CARTON PACK	
24"	S
28"	S
30"	S
32"	S
36"	S
48"	S
60"	S
72"	S

Note: All 1-3/4" doors come 20-minute fire-rated.

HC Hollow Core    SC Solid Core    S - Stock



# MOLDED PANEL DOORS

## 2 Panel Roman



- ▶ Molded panel engineering delivers timeless designs that resist warping, shrinking and cracking.
- ▶ Available in Safe 'N Sound., see page 7 for details.



Available with  
10" Bottom Rail  
(EXTRA CHARGE)

2P ROMAN	1-3/8"						1-3/4"		
	6'8"		7'0"		8'0"		6'8"	7'0"	8'0"
	HC	SC	HC	SC	HC	SC	SC	SC	SC
12"	S	S	.	.	.	.	.	.	.
14"	S	S	.	.	.	.	.	.	.
15"	S	S	.	.	.	.	.	.	.
16"	S	S	.	.	.	.	.	.	.
18"	S	S	.	.	S	S	S	.	.
20"	S	S	.	.	.	.	.	.	.
22"	S	S	.	.	.	.	.	.	.
24"	S	S	.	.	S	S	S	.	S
26"	S	S	.	.	.	.	.	.	.
28"	S	S	.	.	S	S	S	.	S
30"	S	S	.	.	S	S	S	.	S
32"	S	S	.	.	S	S	S	.	S
34"	S	S	.	.	.	.	.	.	.
36"	S	S	.	.	S	S	S	.	S

CARTON PACK	
24"	S
28"	S
30"	S
32"	S
36"	S
48"	S
60"	S
72"	S

Note: All 1-3/4" doors come 20-minute fire-rated.

HC Hollow Core SC Solid Core S - Stock

[masonite.com](http://masonite.com)

# MOLDED PANEL DOORS

Cheyenne.



- ▶ Feature lines define authentic architectural details.
- ▶ Available in Safe 'N Sound., see page 7 for details.



CHEYENNE.	1-3/8"				1-3/4"	
	6'8"		8'0"		6'8"	8'0"
	HC	SC	HC	SC	SC	SC
12"	S	S	.	.	.	.
14"	S	S	.	.	.	.
15"	S	S	.	.	.	.
16"	S	S	.	.	.	.
18"	S	S	S	S	S	.
20"	S	S	.	.	.	.
22"	.	.	.	.	.	.
24"	S	S	S	S	S	S
26"	S	S	.	.	.	.
28"	S	S	S	S	S	S
30"	S	S	S	S	S	S
32"	S	S	S	S	S	S
34"	S	S	.	.	.	.
36"	S	S	S	S	S	S

CARTON PACK	
24"	S
28"	S
30"	S
32"	S
36"	S
48"	.
60"	.
72"	.

Note: All 1-3/4" doors come 20-minute fire-rated.

HC Hollow Core    SC Solid Core    S - Stock

# MOLDED PANEL DOORS

## 2 Panel Arch



- ▶ Molded panel engineering delivers timeless designs that resist warping, shrinking and cracking.
- ▶ Available in Safe 'N Sound., see page 7 for details.



2P ARCH-TOP TEXTURED / SMOOTH	1-3/8"								1-3/4"		
	TEXTURED 6'8"		SMOOTH 6'8"		SMOOTH 7'0"		SMOOTH 8'0"		SMOOTH 6'8"	SMOOTH 7'0"	SMOOTH 8'0"
	HC	SC	HC	SC	HC	SC	HC	SC	SC	SC	SC
16"		.	S		.	.	.	.	.	.	.
18"	S	.	S	S	.	.	.	.	.	.	.
20"	S	.	S	.	.	.	.	.	.	.	.
22"	.	.	.	.	.	.	.	.	.	.	.
24"	S	.	S	S	.	.	.	.	.	.	.
26"	S	.	S	S	.	.	.	.	.	.	.
28"	S	.	S	S	.	.	.	.	.	.	.
30"	S	.	S	S	.	.	.	.	.	.	.
32"	S	.	S	S	.	.	.	.	S	.	.
34"	S	.	S	.	.	.	.	.	.	.	.
36"	S	.	S	S	.	.	.	.	S	.	.

CARTON PACK		
24"	S	.
28"	S	.
30"	S	S
32"	S	.
36"	S	S
48"	.	.
60"	.	.
72"	.	.

Note: All 1-3/4" doors come 20-minute fire-rated. \*Must use ball catch.

HC Hollow Core SC Solid Core S - Stock

[masonite.com](http://masonite.com)

# MOLDED PANEL DOORS

## 4 Panel Square



- ▶ Molded panel engineering delivers timeless designs that resist warping, shrinking and cracking.
- ▶ Available in Safe 'N Sound, see page 7 for details.



20" and smaller becomes 2 panel

4P SQUARE	1-3/8"						1-3/4"		
	6'8"		7'0"		8'0"		6'8"	7'0"	8'0"
	HC	SC	HC	SC	HC	SC	SC	SC	SC
12"	S	S	.	.	.	.	.	.	.
14"	S	S	.	.	.	.	.	.	.
15"	S	S	.	.	.	.	.	.	.
16"	S	S	.	.	.	.	.	.	.
18"	S	S	.	.	.	.	.	.	.
20"	S	S	.	.	.	.	.	.	.
22"	S	S	.	.	.	.	.	.	.
24"	S	S	.	.	.	.	.	.	.
26"	S	S	.	.	.	.	.	.	.
28"	S	S	.	.	.	.	.	.	.
30"	S	S	.	.	.	.	.	.	.
32"	S	S	.	.	.	.	S	.	.
34"	S	S	.	.	.	.	.	.	.
36"	S	S	.	.	.	.	S	.	.

CARTON PACK	
24"	S
28"	S
30"	S
32"	S
36"	S
48"	S
60"	S
72"	S

Note: All 1-3/4" doors come 20-minute fire-rated.

HC Hollow Core    SC Solid Core    S - Stock



# MOLDED PANEL DOORS

Riverside.



- ▶ Feature lines define authentic architectural details.
- ▶ Available in Safe 'N Sound., see page 7 for details.



\*6 Panels for 96" Door

RIVERSIDE.	1-3/8"						1-3/4"		
	6'8"		7'0"		8'0"		6'8"	7'0"	8'0"
	HC	SC	HC	SC	HC	SC	SC	SC	SC
15"	.	.	.	.	.	.	.	.	.
16"	.	.	.	.	.	.	.	.	.
18"	S	S	.	.	S	S	.	.	.
20"	S	.	.	.	.	.	.	.	.
22"	.	.	.	.	.	.	.	.	.
24"	S	S	.	.	S	S	S	.	S
26"	S	.	.	.	.	.	.	.	.
28"	S	S	.	.	S	S	S	.	S
30"	S	S	.	.	S	S	S	.	S
32"	S	S	.	.	S	S	S	.	S
34"	S	.	.	.	.	.	.	.	.
36"	S	S	.	.	S	S	S	.	S

24"	S
28"	.
30"	S
32"	.
36"	S

Note: All 1-3/4" doors come 20-minute fire-rated.

HC Hollow Core    SC Solid Core    S - Stock

# MOLDED PANEL DOORS

## 6 Panel Textured



- ▶ Molded panel engineering delivers timeless designs that resist warping, shrinking and cracking.
- ▶ Available in Safe 'N Sound., see page 7 for details.



6P TEXTURED	1-3/8"						1-3/4"		
	6'8"		7'0"		8'0"		6'8"	7'0"	8'0"
	HC	SC	HC	SC	HC	SC	SC	SC	SC
12"	S	S	.	.	.	.	.	.	.
14"	S	S	.	.	.	.	.	.	.
15"	S	S	.	.	.	.	.	.	.
16"	S	S	.	.	.	.	.	.	.
18"	S	S	.	.	.	.	.	.	.
20"	S	S	.	.	.	.	.	.	.
22"	S	S	.	.	.	.	.	.	.
24"	S	S	.	.	.	.	.	.	.
26"	S	S	.	.	.	.	.	.	.
28"	S	S	.	.	.	.	.	.	.
30"	S	S	.	.	.	.	.	.	.
32"	S	S	.	.	.	.	.	.	.
34"	S	S	.	.	.	.	.	.	.
36"	S	S	.	.	.	.	.	.	.

CARTON PACK		
18"	S	.
24"	S	.
28"	S	.
30"	S	.
32"	S	.
36"	S	.
48"	S	.
60"	S	.
72"	S	.

Note: All 1-3/4" doors come 20-minute fire-rated.

HC Hollow Core    SC Solid Core    S - Stock

# MOLDED PANEL DOORS

## 6 Panel Smooth



- ▶ Molded panel engineering delivers timeless designs that resist warping, shrinking and cracking.
- ▶ Available in Safe 'N Sound., see page 7 for details.



Available with  
10" Bottom Rail  
(EXTRA CHARGE)

6P SMOOTH	1-3/8"						1-3/4"		
	6'8"		7'0"		8'0"		6'8"	7'0"	8'0"
	HC	SC	HC	SC	HC	SC	SC	SC	SC
12"	S	S	.	.	.	.	.	.	.
14"	S	S	.	.	.	.	.	.	.
15"	S	S	.	.	.	.	.	.	.
16"	S	S	.	.	.	.	.	.	.
18"	S	S	.	.	S	S	S	.	.
20"	S	S	.	.	.	.	.	.	.
22"	S	S	.	.	.	.	.	.	.
24"	S	S	.	.	S	S	S	.	S
26"	S	S	.	.	.	.	.	.	.
28"	S	S	.	.	S	S	S	.	S
30"	S	S	.	.	S	S	S	.	S
32"	S	S	.	.	S	S	S	.	S
34"	S	S	.	.	S	S	S	.	.
36"	S	S	.	.	S	S	S	.	S

CARTON PACK	
24"	S
28"	S
30"	S
32"	S
36"	S
48"	S
60"	S
72"	S

Note: All 1-3/4" doors come 20-minute fire-rated.

HC Hollow Core SC Solid Core S - Stock

[masonite.com](http://masonite.com)

# FLUSH SERIES

## Primed Hardboard



- ▶ A simple, flush design provides a clean, contemporary look.
- ▶ Best option for painting.



FLUSH HARDBOARD		1-3/8"						1-3/4"		
		6'8"		7'0"		8'0"		6'8"	7'0"	8'0"
		HC	SC	HC	SC	HC	SC	SC	SC	SC
12"		.	.	.	.	.	.	.	.	.
14"		.	.	.	.	.	.	.	.	.
15"		.	.	.	.	.	.	.	.	.
16"		.	.	.	.	.	.	.	.	.
18"		S	S	.	.	.	.	.	.	.
20"		S	.	.	.	.	.	.	.	.
22"		.	.	.	.	.	.	.	.	.
24"		S	S	.	.	.	.	.	.	.
26"		.	.	.	.	.	.	.	.	.
28"		S	S	.	.	.	.	.	.	.
30"		S	S	.	.	.	.	S	.	.
32"		S	S	.	.	.	.	S	.	.
34"		S	S	.	.	.	.	.	.	.
36"		S	S	.	.	.	.	S	S	.

CARTON PACK	
24"	S
28"	S
30"	S
32"	S
36"	S

Note: All 1-3/4" doors come 20-minute fire-rated.

HC Hollow Core    SC Solid Core    S - Stock



# FLUSH SERIES

## Birch



- ▶ Also available in Wood Stave Birch — call for more info.
- ▶ Available in 6/8 & 7/0 heights; 3/6 & 4/0 widths.



FLUSH BIRCH	1-3/8"						1-3/4"		
	6'8"		7'0"		8'0"		6'8"	7'0"	8'0"
	HC	SC	HC	SC	HC	SC	SC	SC	SC
12"	S	.	.	.	.	.	.	.	.
14"	S	.	.	.	.	.	.	.	.
15"	.	.	.	.	.	.	.	.	.
16"	S	.	.	.	.	.	.	.	.
18"	S	S	.	.	.	.	.	.	.
20"	S	.	.	.	.	.	.	.	.
22"	S	.	.	.	.	.	.	.	.
24"	S	S	.	.	.	.	S	.	.
26"	S	S	.	.	.	.	.	.	.
28"	S	S	.	.	.	.	S	S	.
30"	S	S	.	.	.	.	S	S	.
32"	S	S	.	.	.	.	S	S	.
34"	S	S	.	.	.	.	S	S	.
36"	S	S	.	.	.	.	S	S	S

CARTON PACK	
24"	S
28"	S
30"	S
32"	S
36"	S

Note: All 1-3/4" doors come 20-minute fire-rated. / 2/6, 2/8 & 3/0 widths; 6/8 & 7/0 stocked 90-minute.

HC Hollow Core SC Solid Core S - Stock

[masonite.com](http://masonite.com)

# FLUSH SERIES

Oak



- ▶ A simple, flush design provides a clean, contemporary look.
- ▶ 3/6 & 4/0 Available



FLUSH OAK	1-3/8"						1-3/4"		
	6'8"		7'0"		8'0"		6'8"	7'0"	8'0"
	HC	SC	HC	SC	HC	SC	SC	SC	SC
12"	*	*	*	*	*	*	*	*	*
14"	*	*	*	*	*	*	*	*	*
15"	*	*	*	*	*	*	*	*	*
16"	S	*	*	*	*	*	*	*	*
18"	S	S	*	*	*	*	*	*	*
20"	S	*	*	*	*	*	*	*	*
22"	S	*	*	*	*	*	*	*	*
24"	S	S	*	*	*	*	S	S	*
26"	S	S	*	*	*	*	*	*	*
28"	S	S	*	*	*	*	S	S	*
30"	S	S	*	*	*	*	S	S	*
32"	S	S	*	*	*	*	S	S	*
34"	S	S	*	*	*	*	S	S	*
36"	S	S	*	*	*	*	S	S	S

CARTON PACK	
24"	S
28"	S
30"	S
32"	S
36"	S

**Note:** All 1-3/4" doors come 20-minute fire-rated. / 2/6, 2/8 & 3/0 widths; 6/8 stocked 90-minute. 3/0 width; 7/0 stocked 90-minute.

HC Hollow Core    SC Solid Core    S - Stock

# FLUSH SERIES

## Lauan



► An economy service product.



FLUSH LAUAN		1-3/8"
		6'8"
		HC
	12"	•
	14"	•
	15"	•
	16"	S
	18"	S
	20"	S
	22"	S
	24"	S
	26"	•
	28"	S
	30"	S
	32"	S
	34"	S
	36"	S
CARTON PACK		
	24"	S
	28"	S
	30"	S
	32"	S
	36"	S

**Note:** All 1-3/4" doors come 20-minute fire-rated.

HC Hollow Core    SC Solid Core    **S - Stock**



# FLUSH SERIES

Regency Walnut & Imperial Oak



Imperial Oak



Regency Walnut

► Prefinished for your convenience.

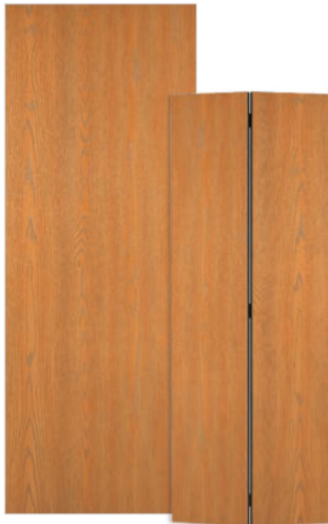

FLUSH IMPERIAL OAK	1-3/8"		1-3/4"
	HC	SC	6'8" SC
12"		•	•
14"	•	•	•
15"	•	•	•
16"	S	•	•
18"	S	•	•
20"	S	•	•
22"	S	•	•
24"	S	•	•
26"	S	•	•
28"	S	•	•
30"	S	•	S
32"	S	•	20/90 S
34"	S	•	•
36"	S	•	20/90 S

CARTON PACK	
24"	S
28"	S
30"	S
32"	S
36"	S

Note: All 1-3/4" doors come 20-minute fire-rated.

HC Hollow Core SC Solid Core S - Stock



# 6P PREFINISHED

## Regal Oak



- ▶ Durable topcoat ensures a long-lasting finish.
- ▶ Resists warping, shrinking and cracking better than solid wood doors.



6P AMBER OAK		1-3/8"		1-3/4"
		6'8"		6'8"
		HC	SC	SC
	12"	.	.	.
	14"	.	.	.
	15"	.	.	.
	16"	.	.	.
	18"	S	.	.
	20"	.	.	.
	22"	.	.	.
	24"	S	.	.
	26"	.	.	.
	28"	S	.	.
	30"	S	.	.
	32"	S	.	.
	34"	S	.	.
	36"	S	.	.
CARTON PACK				
	24"	S		
	28"	.		
	30"	S		
	32"	.		
	36"	S		

Note: All 1-3/4" doors come 20-minute fire-rated.

HC Hollow Core    SC Solid Core    S - Stock

# Hardwood Lites

- ▶ Great for commercial doors
- ▶ Not available as exterior use

## SHOWN IN OAK



Style 41



Style 400



Style 9



Style 200

## SHOWN IN BIRCH



Style 300



Style 104-F



Style 109-F



Style 184

# Anatomy of a Door

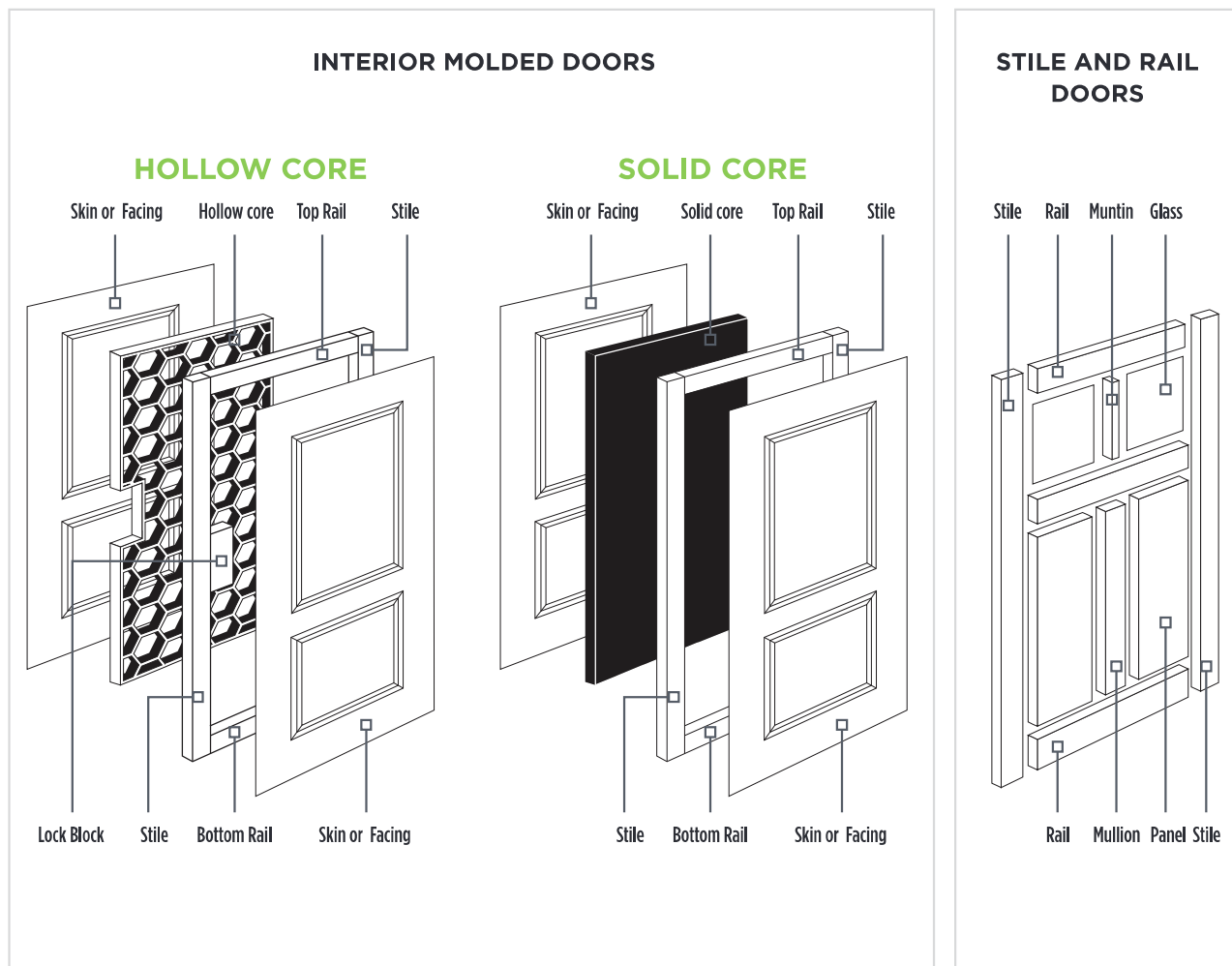

## ANATOMY OF DOORS DEFINED

**MULLION:** narrow vertical sections between panels

**MUNTIN:** slim vertical pieces used to separate panes of glass; grille bar

**PANEL:** pieces that fit within the surrounding stile & rail frame that come in different profile designs - single-hip, double-hip and flat

**RAIL:** horizontal pieces of the door; includes top, bottom and sometimes lock rails

**STICKING:** the design of the profile edge on the stile and rail; ovolo is carved and rounded; shaker is straight and squared

**STILE:** vertical pieces of the door

# Door Accessories

## JAMB TYPE



FLAT



2-PIECE SPLIT



3-PIECE SPLIT



SUPER JAMBS

## JAMB MATERIAL



PINE VENEER  
JAMB

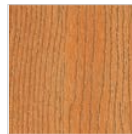

IMPERIAL OAK  
JAMB

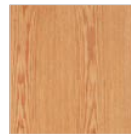

OAK VENEER  
JAMB



SOLID PINE  
JAMB



SOLID POPLAR  
JAMB



KNOTTY ALDER  
JAMB

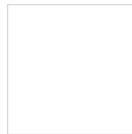

SOLID OAK  
JAMB



SOLID MAPLE  
JAMB



5/4 FLAT WP  
7/0"  
JAMB



5/4 FLAT OAK  
7/0"  
JAMB



SOLID CHERRY  
JAMB

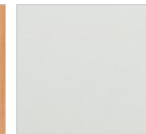

PFJ JAMB  
W/ NAIL HOLES

## SUPERJAMB FEATURES:

- ▶ Carbon coated
- ▶ Semi prefinished
- ▶ No caulking required
- ▶ Less expensive
- ▶ Easier & quicker to install
- ▶ More consistent than a nail hole jambs
- ▶ LVL construction

## CASING MATERIAL

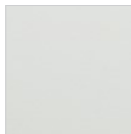

PRIMED (PR)



PINE (PN)



IMPERIAL OAK

## CASING PROFILES



361  
PROFILE



366  
PROFILE



376  
PROFILE



356  
PROFILE



327  
PROFILE

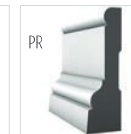

ADAMS 97  
PROFILE



445  
PROFILE



452  
PROFILE



3120  
PROFILE



S4S  
PROFILE



WM412  
PROFILE

## HINGE TYPE



PLAIN BEARING  
(PB)



DOUBLE  
ACTING



PIVOT FLOOR  
MOUNT



BALL BEARING  
(BB)



SPRING (S)

## HINGE FINISH



US15  
(PB, BB, S)

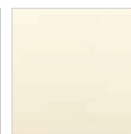

US3  
(PB, BB, S)



US10R  
(PB, BB, S)



US26D  
(PB, BB, S)



US26  
(PB, BB, S)

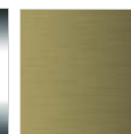

ABA  
(PB, BB, S)



US15A  
(PB, BB, S)



IB1D BLACK  
(PB, BB, S)



US4  
(PB, BB, S)



LIGHT BRASS  
(3LB) (PB)



# Barn Door Hardware



Barn door options from Masonite deliver trend-forward design solutions that are both stylish and functional. Choose from three, easy-to-install track options to create flexible interior spaces packed with character.

## SHUSTER'S STOCKS A FULL LINE OF BARN DOOR HARDWARE & ACCESSORIES TO ACCOMMODATE MANY DOOR PANEL DESIGN AND OPENINGS.

- ▶ Handles
- ▶ Misc parts
- ▶ Soft close feature
- ▶ Bi-pass systems

**HARDWARE** - Available in 78-3/4" & 96-3/4" lengths



**Straight Strap**  
Matte Black



**Bent Strap**  
Matte Black



**Top Mount**  
Stainless Steel

### Finish Options



Stainless  
Steel



Matte  
Black

# Door Handing Chart

## PREHUNG HANDING

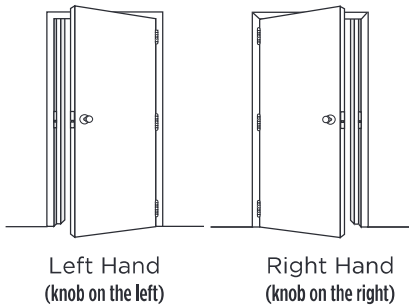

## BIFOLD HANDLING

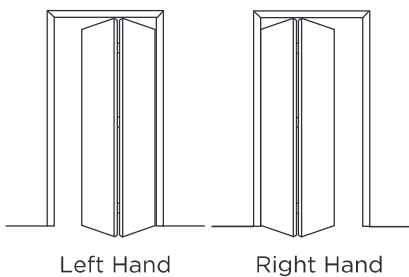

## FRENCH OPENING

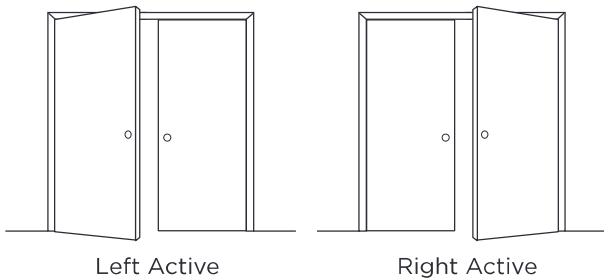

ROUGH OPENING & NET UNIT SIZES FOR ALL INTERIOR DOORS				
Add to Nominal Size Prehung Unit	Rough Opening		Unit Size Net Size / No CSG	
	Height Add	Width Add	Height Add	Width Add
Solid Jamb Unit	2-1/2"	2"	1-3/4"	1-7/16"
Split Jamb Unit	2-1/2"	2"	1-3/4"	1-7/16"
French Opening Unit	2-1/2"	2"	1-3/4"	1-7/16"
Bypass Prehung Unit	2-1/2"	1"	1-3/4"	7/16"
Bifold Prehung Unit	2-1/2"	2"	1-3/4"	1-7/16"

**Note:** Add 3/4" to above when using 5/4" jamb option for width.  
Add 3/8" to height.

## FINISHED OPENING REQUIREMENTS

Carton Bifold	Nominal Width x 80-3/4" Height
---------------	--------------------------------

**LOCK PREP #3:** 2-3/8" backset, 2-1/4" Latch Face Height, 1" Latch Face Width, 1/4" Radius corner, 2-1/8" Face Bore, 1" Edge Hole, 2-1/4" Strike Height

**LOCK PREP #2\*:** 2-3/4" backset, 2-1/4" Latch Face Height, 1" Latch Face Width, 1/4" Radius corner, 2-1/8" Face Bore, 1" Edge Hole, 2-1/4" Strike Height

*\*Prep #2 is rarely used on interior doors. Does not work with 4-1/2" stiles.*

**Note:** The lock prep for 7/0 & 8/0 door does not line up with a 6/8 door

## SBC STRIKE

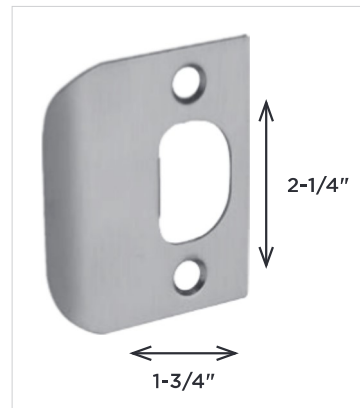

SHUSTER'S BUILDING COMPONENTS				
FOR 1-3/8" DOOR - HINGE & LOCK PREP LOCATIONS FOR 3.5 X 3.5" HINGES, .097" DEPTH				
DRIA	6/8	TOP OF DOOR TO TOP OF FIRST HINGE	7"	
		TOP OF DOOR TO TOP OF SECOND HINGE	36-1/4"	
		TOP OF DOOR TO TOP OF THIRD HINGE	65-1/2"	
		TOP OF DOOR TO C/L OF LOCK PREP	44"	
DR3	7/0	TOP OF DOOR TO TOP OF FIRST HINGE	7"	
		TOP OF DOOR TO TOP OF SECOND HINGE	36-1/4"	
		TOP OF DOOR TO TOP OF THIRD HINGE	65-1/2"	
		TOP OF DOOR TO C/L OF LOCK PREP	46"	
DR96	8/0	TOP OF DOOR TO TOP OF FIRST HINGE	7"	
		TOP OF DOOR TO TOP OF SECOND HINGE	32"	
		TOP OF DOOR TO TOP OF THIRD HINGE	57"	
		TOP OF DOOR TO TOP OF FOURTH HINGE	82"	
		TOP OF DOOR TO C/L OF LOCK PREP	60"	

**Note:** Not all lock preps are meant to align in lock rail.

This material may not be reproduced in its entirety or in part, in any form whatsoever.  
Prices as specifications subject to change without notice.





  
**MASONITE.**  
 Open to extraordinary.  
[masonite.com](http://masonite.com)

**SHUSTER'S**  
 BUILDING COMPONENTS



2920 Clay Pike  
 North Huntingdon, PA 15642-3098  
 P: 724.446.7000 | 800.735.9899  
 E: sales@shusters.com  
 shusters.com



# Max

Masonite Xpress Configurator.

In just a few clicks, browse thousands of door styles and glass options to create your dream door.

FRONT COVER: Livingston.  
 BACK COVER: Pine 1501

**⚠ WARNING:** This product can expose you to chemicals including wood dust, which is known to the State of California to cause cancer. For more information, go to [www.P65Warnings.ca.gov](http://www.P65Warnings.ca.gov).

SHU-18402